

## 1. DOOR & MOLDING STYLE CHOICE

- 06 Wyndham Hill       11 Pendelton       17 Mill Creek  
 20 Barrington       33 Coventry       44 Brighton Harbour  
 51 American Traditions       54 Horizons       65 Harmony

## 2. WOOD CHOICE

- Cherry     Maple     Oak     Quarter sawn Oak

## 3. FINISH Refer to store kiosk for finish colors.

- Stain     Glazed Finish     Glazed Finish with Olde World Distressing  
 Passages Handrubbed Finish     Paint

Finish Name: \_\_\_\_\_

## 4. DISTRESSING

- No Distressing  
 Distressing (random nicks & dents and wear sanded edges prior to finish)  
 Antique Detailing (random nicks, dents, wear sanded edges prior to finish, rasp marks, and worm holes)

included with Olde World or Passages finish selection above:

- Olde World Distressing (random nicks, dents, wear sanded edges prior to finish, rasp marks, worm holes, gouges and glaze)  
 Passages Handrubbed Finish Distressing (random nicks, dents, wear sanded edges prior to finish, rasp marks, and worm holes)

## 5. LACQUER

- Satin Lacquer     Flat Lacquer

## 6. HARDWARE

Number: \_\_\_\_\_ Description: \_\_\_\_\_

## 7. GLASS

- None     Plain     Antique     Beveled     Brass Bevel Lead     Frosted  
 Lead     Mission Lead     Seeded     Straw     Wood Grills

## 8. MOLDING

The Custom Shoppe will complete moldings between cabinets. Describe ends of grouping.

- Molding on outside edges     No molding on outside edges  
 Other, describe:

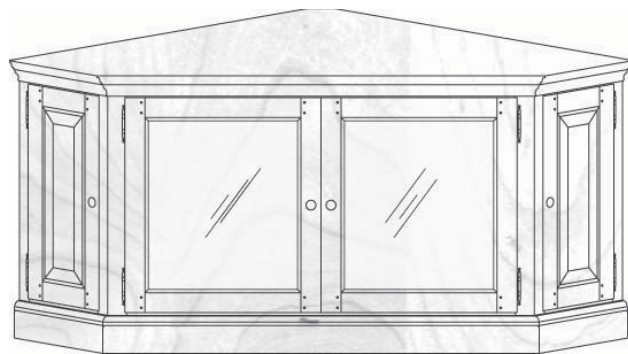

(51) American Traditions shown, over for other styles

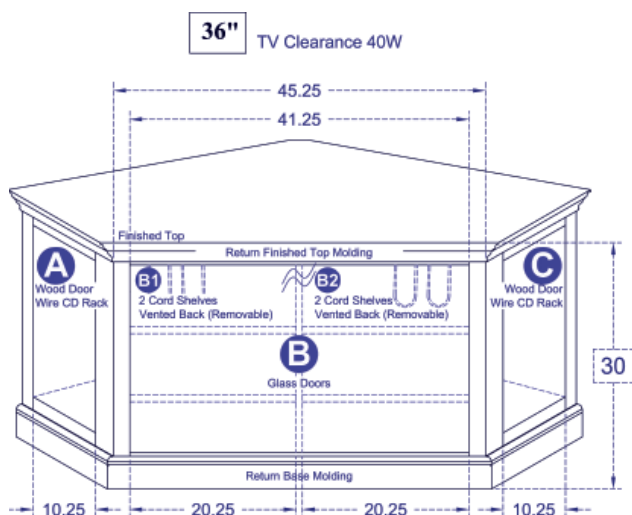

### STANDARD DIMENSIONS AND CUSTOM CAPABILITIES

<b>MINIMUM:</b>	23H	45.25ATW	28.5D
<b>STANDARD:</b>	30.0H	45.25ATW	
<b>MAXIMUM:</b>	60H	45.25ATW	28.5D

## DIMENSIONS

Review the standard cabinet dimensions above and note any changes required within minimum and maximum dimensions (fees apply) to accommodate your TV, components or wall.

## OPTIONAL FEATURES

Extra shelves? Legs? Lighting? Cord Holes? Add or remove features for design ideas and storage needs.

## ANYTHING ELSE?

Is there something you need, that you cant find in our literature - write your ideas and questions here.

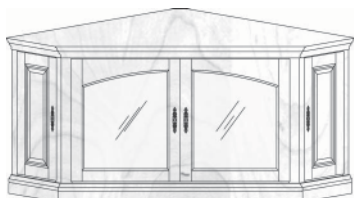

**CC0690**  
46.875ATW

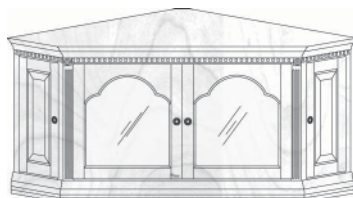

**CC1190**  
46.875ATW



**CC1790**  
46.875ATW

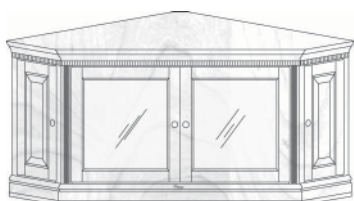

**CC2090**  
46.875ATW

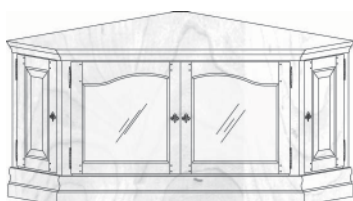

**CC3390**  
46.875ATW

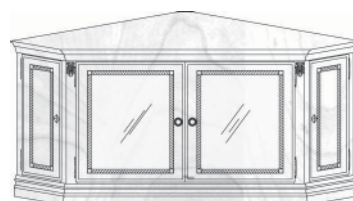

**CC4490**  
46.875ATW

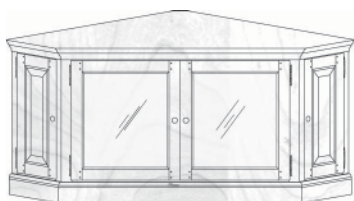

**CC5190**  
46.875ATW

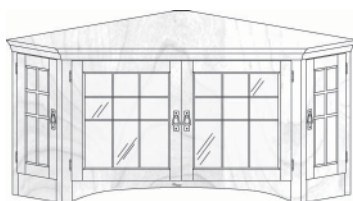

**CC5490**  
46.875ATW  
Shown with optional Mission Glass.

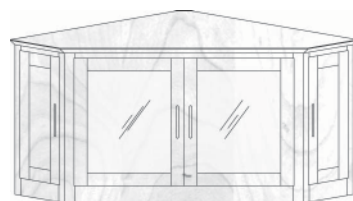

**CC6590**  
46.5ATW